

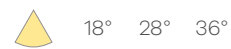

AURA

Foco orientable para carril electrificado
Adjustable spotlight for electrified track

- Proyector orientable para carril trifásico
- Potencia: 30 W
- Voltaje: 230 VAC | 48 VDC
- Regulable: inclinación 90° | rotación 350°
- Real flicker-free
- Acabados: Blanco | RAL a elegir
- Adjustable spotlight for three phase track
- Power: 30 W
- Voltage: 230 VAC | 48 VDC
- Adjustable: 90° tilt | 350° rotation
- Real flicker-free
- Finishes: White | RAL to choose



DALI





DESCRIPCIÓN | DESCRIPTION

Aura es un proyector LED ajustable de diseño atemporal y minimalista, que proporciona gran confort visual para el canal retail, HORECA y museístico.

La luminaria está disponible en dos temperaturas de color monocromáticas (3000 K, 4000 K), Tunable White (2700 K - 5000 K), y tres ángulos de apertura; 18°, 28° o 36°. Fuente de alimentación integrada.

Aura is a timeless and minimal adjustable LED projector, that provides a high visual comfort for retail, hospitality, museums or exhibition application.

The luminaire is available in two monochromatic colour temperatures (3000 K, 4000 K), Tunable White (2700 K - 5000 K), and three different beam angles; 18°, 28° or 36°. Build-in power supply.

CARACTERÍSTICAS TÉCNICAS | TECHNICAL SPECIFICATIONS

AURA White

Referencia Reference	Voltaje Voltage V AC	Potencia Power W	f.d.p PF	Temp. color Color temp. K	CRI	Flujo Flux lm	Eficiencia Efficiency lm/W	Ángulo Beam °	Cantidad Number LED	Regulación Dimmer
LFG-	230	30	>0.97	3000	>90	2157	72	18 28 36	1	DALI DT6
				4000		2693	89			

AURA Tunable White

Referencia Reference	Voltaje Voltage V DC	Potencia Power W	Temp. color Color temp. K	CRI	Flujo Flux lm	Eficiencia Efficiency lm/W	Ángulo Beam °	Cantidad Number LED	Regulación Dimmer
LFG-	48	30	2700 - 5000	>90	2250	75	18 28 36	1	DALI DT6 DALI DT8

CARACTERÍSTICAS FÍSICAS | PHYSICAL SPECIFICATIONS

Referencia Reference	Orientación Orientation °	Temp. trabajo Work temp. °C	Temp. stock Stock temp. °C	Dimensiones Dimensions mm	Peso Weight Kg
LFG-	2 ejes axis: 350° 90°	-15 - +40	-20 - +60	Ø 37	0,824

Referencia Reference	Protección Protection	Disipación Disipation	Radiador Radiator	Acabado Finish
LFG-	IP20	Pasiva Passive	Aluminio anodizado Anodized aluminum	Blanco RAL a elegir White RAL to choose

Otras temperaturas de color y CRI bajo pedido | Different colour temperatures and CRI under request

* Opcional | Optional

EMBALAJE | PACKAGING

Referencia Reference	Unidades por caja Units per box	Dimensiones Dimensions mm	Peso Weight kg
LFG-	1	203x271x103	1,038

FOTOMETRÍA | PHOTOMETRY

18°

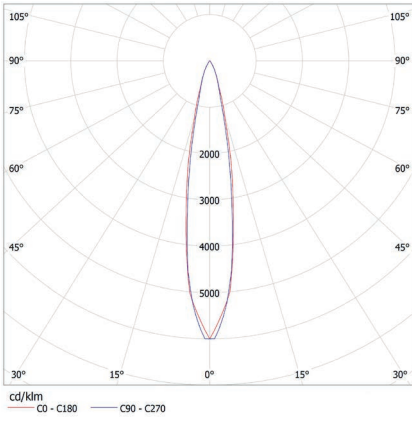

28°

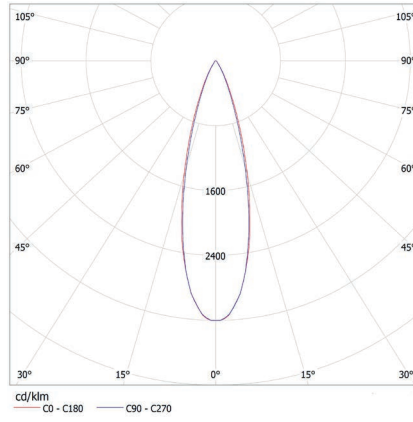

36°

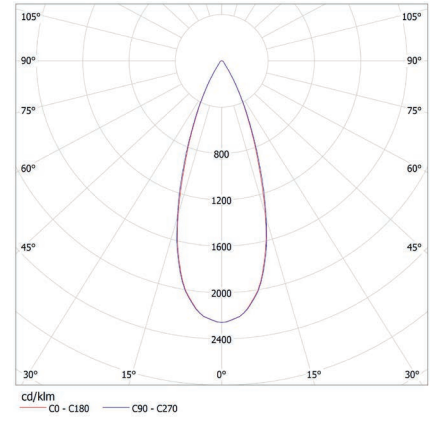

DIMENSIONES | DIMENSIONS mm

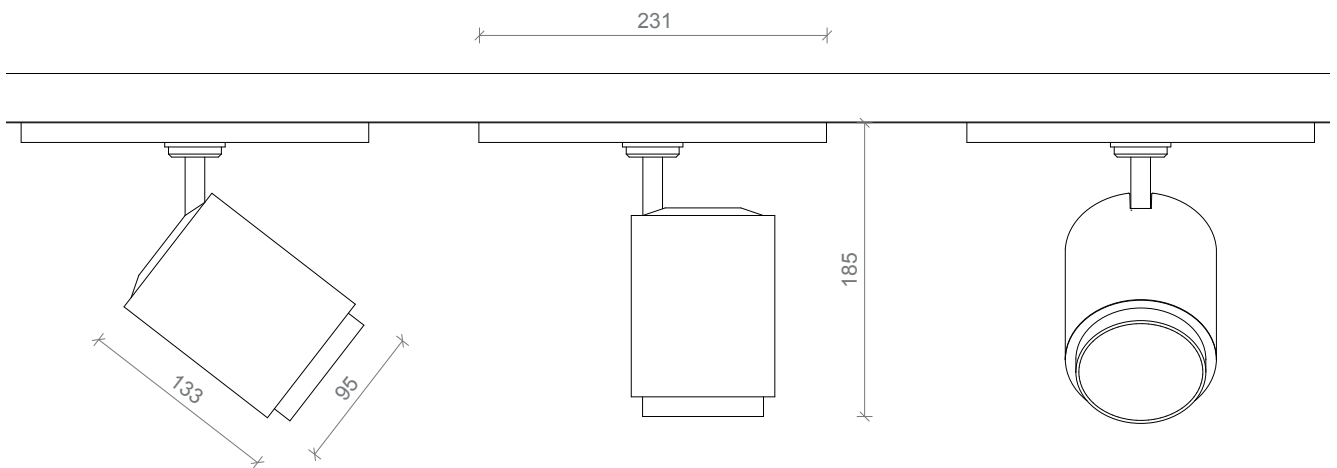

AURA Tunable White | DALI

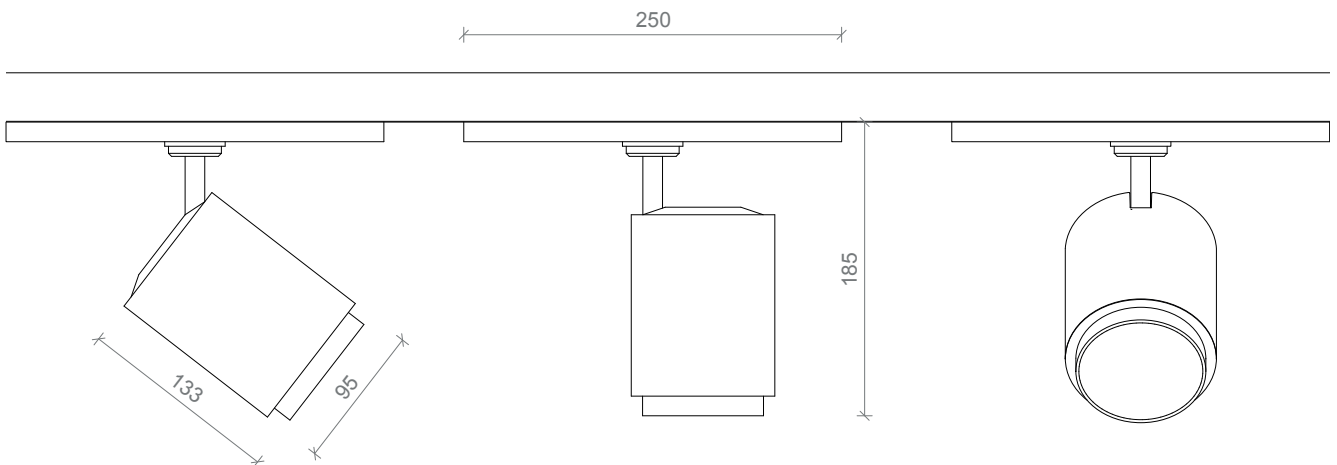

ACCESORIOS | ACCESSORIES

Carril electrificado | Electrified track

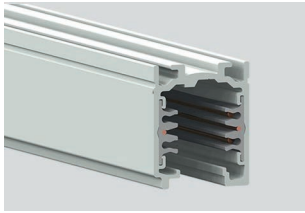

C1



T1



S2



S1

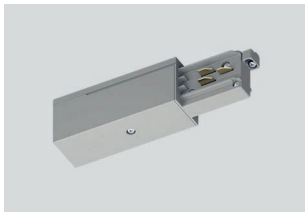

A2



A1



U1



U2



U3

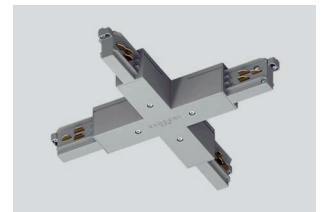

U4

Sin carril electrificado | Without electrified track











B1



B2

Artículo Item	Imagen Image	Referencia Reference	Descripción Description	Esquema (vista superior) Diagram (top view)
Carril Track	C1	STU-9000-2/W-ST	Carril electrificado 2000 mm, blanco Conductors track 2000 mm, white	
		STU-9000-3/W-ST	Carril electrificado 3000 mm, blanco Conductors track 4000 mm, white	
		STU-9000-2/B-ST	Carril electrificado 2000 mm, negro Conductors track 2000 mm, black	
		STU-9000-3/B-ST	Carril electrificado 3000 mm, negro Conductors track 2000 mm, black	

Tapa End cap	T1	STU-9004/W	Tapa final para carril, blanco End cap for conductors track, white	
		STU-9004/B	Tapa final para carril, negro End cap for conductors track, black	
Anclaje Moorings	S1	STU-9000/111	Fijación techo superficie Fixed surface ceiling	
	S2	STU-9000-KIT-8	Fijación techo suspendido Fixed suspended ceiling	
Alimentador extremo End-feed	A1	STU-9001/W	Alimentador extremo polaridad derecha, blanco End-feed right, white	
		STU-9001/B	Alimentador extremo polaridad derecha, negro End-feed right, black	
		STU-9002/W	Alimentador extremo polaridad izquierda, blanco End-feed left, white	
		STU-9002/B	Alimentador extremo polaridad izquierda, negro End-feed left, black	
Alimentador medio Middle feet	A2	STU-9010/W	Unión electrificada para carriles, blanco Joining connector, white	
		STU-9010/B	Unión electrificada para carriles, negro Joining connector, black	
Conector de unión Joining connector	U1	STU-9003/W	Toma de alimentación intermedia, blanco Middle feed, white	
		STU-9003/B	Toma de alimentación intermedia, negro Middle feed, black	
Unión L L-feet	U2	STU-9011/W	Unión L, Polaridad interna, blanco L-feet, Internal polarity, white	
		STU-9011/B	Unión L, Polaridad interna, negro L-feet, Internal polarity, black	
		STU-9012/W	Unión L, Polaridad externa, blanco L-feet, External polarity, white	
		STU-9012/B	Unión L, Polaridad externa, negro L-feet, External polarity, black	
Unión T T-feet	U3	STU-9013/W	Unión T, Polaridad externa-izquierda, blanco T-feet, External-left polarity, white	
		STU-9013/B	Unión T, Polaridad externa-izquierda, negro T-feet, External-left polarity, black	
		STU-9014/W	Unión T, Polaridad externa-derecha, blanco T-feet, External-right polarity, white	
		STU-9014/B	Unión T, Polaridad externa-derecha, negro T-feet, External-right polarity, black	
		STU-9015/W	Unión T, Polaridad interna-izquierda, blanco T-feet, External-left polarity, white	
		STU-9015/B	Unión T, Polaridad interna-izquierda, negro T-feet, External-left polarity, black	
		STU-9016/W	Unión T, Polaridad interna-derecha, blanco T-feet, External-right polarity, white	
		STU-9016/B	Unión T, Polaridad interna-derecha, negro T-feet, External-right polarity, black	
Unión X X-feet	U4	STU-9017/W	Unión X, blanco X-feet, white	
		STU-9017/B	Unión X, blanco X-feet, white	
Base Base	B1	STU-9000/BP-D-W	Base fijación techo (sin carril), blanco Celing fixing base (without track), white	
Adaptador base Base adaptor	B2	STU-9009/W	Adaptador (sin carril), blanco Adaptor (without track), white	
		STU-9009/B	Adaptador (sin carril), negro Adaptor (without track), black	

ESQUEMA MONTAJE | ASSEMBLY SCHEME

Configuración - ejemplo 1 | Configuration - example 1

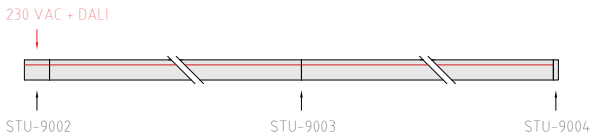

Configuración - ejemplo 2 | Configuration - example 2

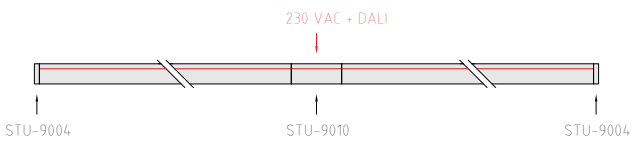

Configuración - ejemplo 3 | Configuration - example 3

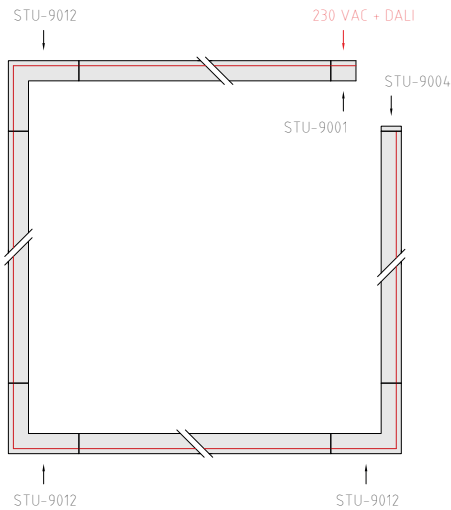

Configuración - ejemplo 4 | Configuration - example 4

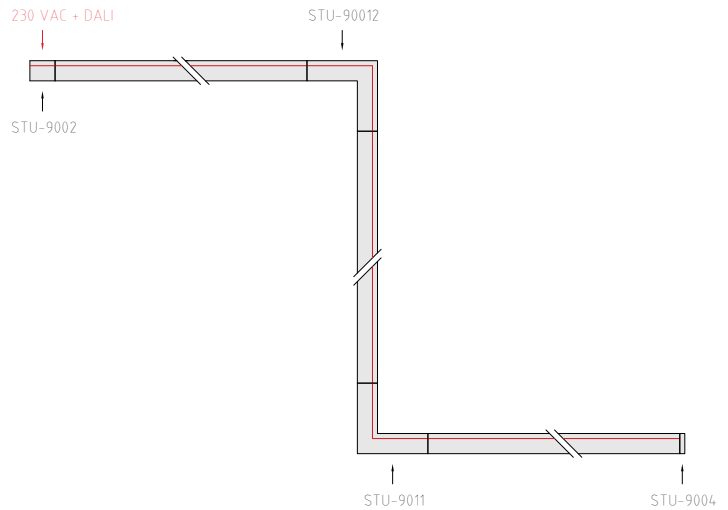

Vista superior
Top view

Fijación techo | Fixed ceiling

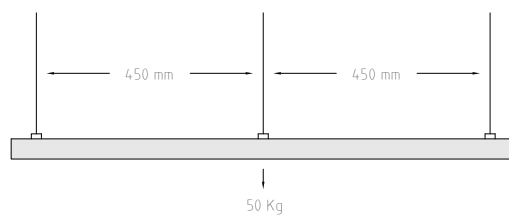
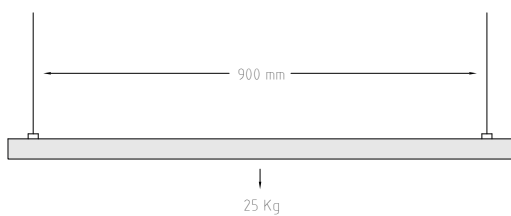

Vista frontal
Front view

ESQUEMA ELÉCTRICO | ELECTRICAL SCHEME

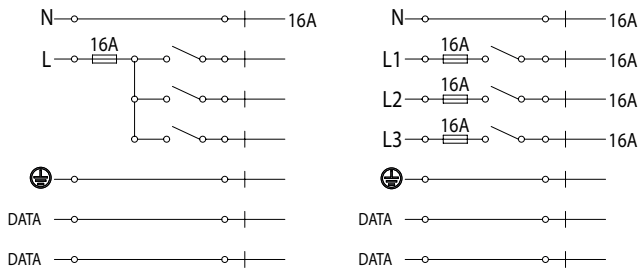

GUÍA DE REFERENCIAS | REFERENCES GUIDE

LFG-30S-NNN-JBE-AEJ	AURA, 3000 K CRI>90, 18°, Blanco, 30 W, 230 VAC, Carril electrificado de superficie 3 fases + datos AURA, 3000 K CRI>90, 18°, White, 30 W, 230 VAC, Surface track three phase + data
LFG-30S-NNN-JCE-AEJ	AURA, 3000 K CRI>90, 28°, Blanco, 30 W, 230 VAC, Carril electrificado de superficie 3 fases + datos AURA, 3000 K CRI>90, 28°, White, 30 W, 230 VAC, Surface track three phase + data
LFG-30S-NNN-JDE-AEJ	AURA, 3000 K CRI>90, 36°, Blanco, 30 W, 230 VAC, Carril electrificado de superficie 3 fases + datos AURA, 3000 K CRI>90, 36°, White, 30 W, 230 VAC, Surface track three phase + data
LFG-40S-NNN-JBE-AEJ	AURA, 4000 K CRI>90, 18°, Blanco, 30 W, 230 VAC, Carril electrificado de superficie 3 fases + datos AURA, 4000 K CRI>90, 18°, White, 30 W, 230 VAC, Surface track three phase + data
LFG-40S-NNN-JCE-AEJ	AURA, 4000 K CRI>90, 28°, Blanco, 30 W, 230 VAC, Carril electrificado de superficie 3 fases + datos AURA, 4000 K CRI>90, 28°, White, 30 W, 230 VAC, Surface track three phase + data
LFG-40S-NNN-JDE-AEJ	AURA, 4000 K CRI>90, 36°, Blanco, 30 W, 230 VAC, Carril electrificado de superficie 3 fases + datos AURA, 4000 K CRI>90, 36°, White, 30 W, 230 VAC, Surface track three phase + data
LFG-TAD-NNN-JBE-AEI	AURA, TUNABLE WHITE, CRI>90, 18°, Blanco, 27 W, 48 VDC, Carril electrificado de superficie 3 fases + datos AURA, TUNABLE WHITE, CRI>90, 18°, White, 27 W, 48 VDC, Surface track three phase + data
LFG-TAD-NNN-JCE-AEI	AURA, TUNABLE WHITE, CRI>90, 28°, Blanco, 27 W, 48 VDC, Carril electrificado de superficie 3 fases + datos AURA, TUNABLE WHITE, CRI>90, 18°, White, 27 W, 48 VDC, Surface track three phase + data
LFG-TAD-NNN-JDE-AEI	AURA, TUNABLE WHITE, CRI>90, 36°, Blanco, 27 W, 48 VDC, Carril electrificado de superficie 3 fases + datos AURA, TUNABLE WHITE, CRI>90, 18°, White, 27 W, 48 VDC, Surface track three phase + data