



COMET W50

Proyectores lineales, potencia y calidad de luz
Linear projectors, power and light quality

- Proyector lineal de alto rendimiento lumínico
 - Potencia: 30 W/m y 50 W/m
 - Conexión en serie fácil y rápida
 - Voltaje: 110-230 VAC | 120-277 VAC
 - Cuerpo: Aluminizado
- High efficiency linear lighting fixture
 - Power: 30 W/m & 50 W/m
 - Easy and quick serial connection
 - Voltage: 110-230 VAC | 120-277 VAC
 - Body: Anodized Aluminium





DESCRIPCIÓN | DESCRIPTION

COMET W50 es una luminaria lineal de alto rendimiento lumínico y gran confort visual, diseñada para crear efectos wall-washer en fachadas y aplicaciones arquitecturales de exterior.

Disponible en dos temperaturas de color monocromáticas (3000 K, 4000 K), tunable white, y RGB+W. Además, para un mayor control de la luz se ofrece una amplia gama de ángulos de apertura; 9°, 28°,48°, 48x12°. Fuente de alimentación integrada. Control PWM, DMX o DALI.

COMET 45 CC is a high luminous efficiency linear lighting luminaire, designed to highlight facades and outdoor architectural lighting applications, offering a comfortable and efficient wall washing effect.

The luminaire is available in two monochromatic colour temperatures (3000 K, 4000 K), tunable white or colour changing RGB+W. Wide range of optics for accent and flood light distributions; 9°, 28°,48°, 48x12°. Build-in power supply. Control type by PWM, DMX or DALI.

CARACTERÍSTICAS TÉCNICAS | TECHNICAL SPECIFICATIONS

Comet W50 35 W/m White

Referencia Reference Modelo Model	Voltaje Voltage VAC	Potencia Power W	Frecuencia Frequency Hz	f.d.p PF	Temp. color Color temp. K	CRI	Flujo Flux lm	Eficiencia Efficiency lm/W	Ángulo Beam °	Cantidad Number LED/m	Regulación Dimmer
LCP-300-060-CxP-5GG Comet W50 600	110 ~ 230	21	50 ~ 60	0,95	3000	>80	2310	110	9 28 48 48x12	24	PWM DALI* DMX*
LCP-300-060-CxP-5EG Comet W50 600						>90	2079	99			
LCP-400-060-CxP-5GG Comet W50 600						>80	2499	119			
LCP-400-060-CxP-5EG Comet W50 600						>90	2310	110			
LCP-300-090-CxP-5GI Comet W50 900		32			3000	>80	3520	110		36	
LCP-300-090-CxP-5EI Comet W50 900						>90	3168	99			
LCP-400-090-CxP-5GI Comet W50 900						>80	2808	119			
LCP-400-090-CxP-5EI Comet W50 900						>90	3520	110			
LCP-300-120-CxP-5GJ Comet W50 1200		45			3000	>80	4950	110		48	
LCP-300-120-CxP-5EJ Comet W50 1200						>90	4455	99			
LCP-400-120-CxP-5GJ Comet W50 1200						>80	5355	119			
LCP-400-120-CxP-5EJ Comet W50 1200						>90	4950	110			

Comet W50 50 W/m White

LCP-300-060-CxP-5GI Comet W50 600	110 ~ 230	30	50 ~ 60	0,95	3000	>80	3110	104	9 28 48 48x12	24	PWM DALI* DMX*
LCP-300-060-CxP-5EI Comet W50 600						>90	2819	94			
LCP-400-060-CxP-5GI Comet W50 600						>80	3363	112			
LCP-400-060-CxP-5EI Comet W50 600						>90	3110	104			
LCP-300-090-CxP-5GK Comet W50 900		45			3000	>80	4666	104		36	
LCP-300-090-CxP-5EK Comet W50 900						>90	4228	94			
LCP-400-090-CxP-5GK Comet W50 900						>80	5045	112			
LCP-400-090-CxP-5EK Comet W50 900						>90	4666	104			
LCP-300-120-CxP-5GL Comet W50 1200		60			3000	>80	6221	104		48	
LCP-300-120-CxP-5EL Comet W50 1200						>90	5602	94			
LCP-400-120-CxP-5GL Comet W50 1200						>80	6726	112			
LCP-400-120-CxP-5EL Comet W50 1200						>90	6221	104			



Comet W50 Tunable White

Referencia Reference Modelo Model	Voltaje Voltage VAC	Potencia Power W	Frecuencia Frequency Hz	f.d.p PF	Temp. color Color temp. K	CRI	Flujo Flux lm	Eficiencia Efficiency lm/W	Ángulo Beam °	Cantidad Number LED/m	Regulación Dimmer
LCP-TAO-060-xxP-xGH Comet W50 600	230	25	50 ~ 60	0,95	Tunable White 2700 ~ 5000	>80	2600	104	9 28 48 48x12	WW: 12 CW: 12	PWM DALI* DMX*
LCP-TAO-060-xxP-xEH Comet W50 600						>90	2400	96			
LCP-TAO-090-xxP-xGJ Comet W50 900		38				>80	3952	104		WW: 18 CW: 18	
LCP-TAO-090-xxP-xEJ Comet W50 900						>90	3648	96			
LCP-TAO-120-xxP-xGK Comet W50 1200		50				>80	5200	104		WW: 24 CW: 24	
LCP-TAO-120-xxP-xEK Comet W50 1200						>90	4800	96			

Comet W50 RGB + White

Referencia Reference Modelo Model	Voltaje Voltage VAC	Potencia Power W	Frecuencia Frequency Hz	f.d.p PF	Temp. color Color temp. K	CRI	Color Color nm	Flujo Flux lm	Ángulo Beam °	Cantidad Number LED/m	Regulación Dimmer
LCP-RWO-060-CxP-5NK Comet W50 600	120 - 277	25	50 ~ 60	>0,95	W: 4000	>80	R: 623 G: 525 B: 460	R: 468 G: 562 B: 158 W: 900	9 28 48 48x12	24	PWM DALI* DMX*
LCP-RWO-090-CxP-5NK Comet W50 900		38						R: 702 G: 842 B: 138 W: 1350		36	
LCP-RWO-120-CxP-5NK Comet W50 1200		50						R: 936 G: 1123 B: 317 W: 1800		48	

CARACTERÍSTICAS FÍSICAS | PHISICAL SPECIFICATIONS

Referencia Reference Modelo Model	Orientación Orientation °	Temp. trabajo Work temp. °C	Temp. stock Stock temp. °C	Dimensiones Dimensions mm	Peso Weight kg
LCP-xxO-060-CxP-5xx Comet W50 600	180*	-20 ~ +45	-30 ~ +50	65x45x624	2,6
LCP-xxO-090-CxP-5xx Comet W50 900				65x45x928	3
LCP-xxO-120-CxP-5xx Comet W50 1200				65x45x1234	3,6

Referencia Reference	Protección Protection	Disipación Disipation	Radiador Radiator	Acabado Finish
LCP-	IP66	Pasiva Passive	Aluminio anodizado Anodized aluminium	Anodizado plata Silver anodized

Otras temperaturas de color y CRI bajo pedido | Different colour temperatures and CRI under request

* Opcional | Optional



FOTOMETRÍA | PHOTOMETRY

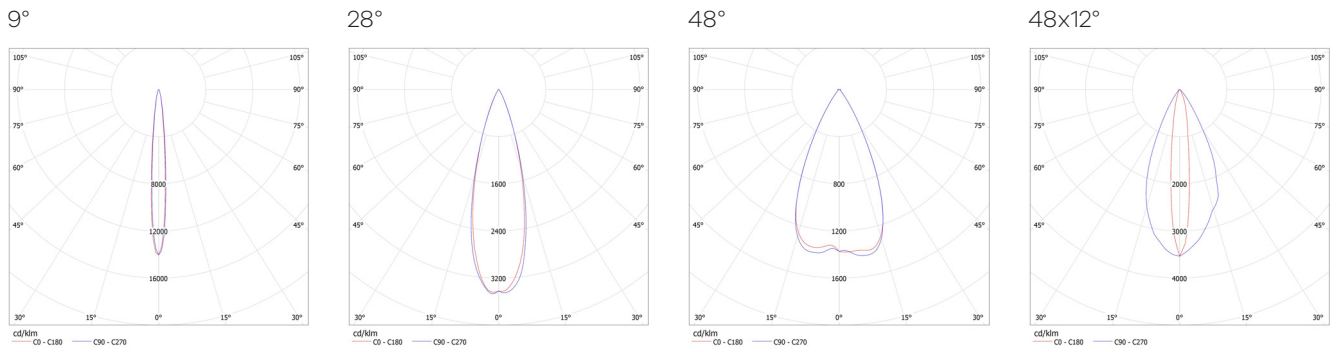

DIMENSIONES | DIMENSIONS mm

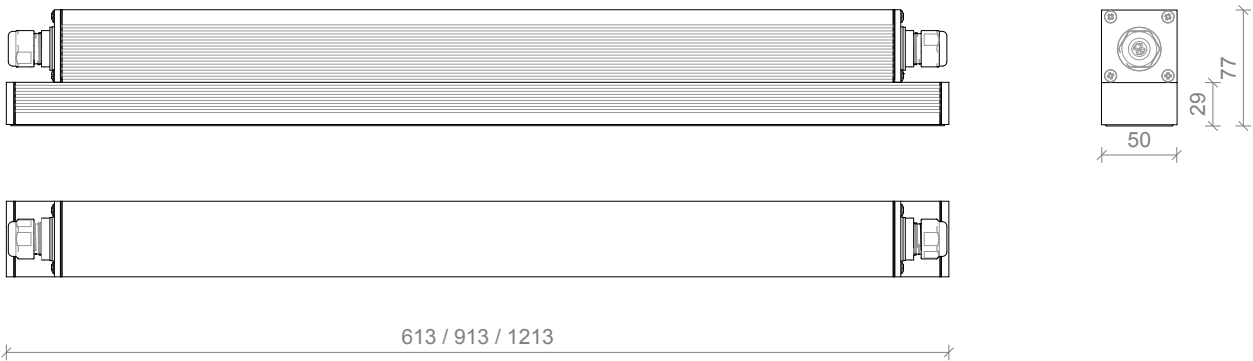

Por encargo se pueden realizar en diferentes medidas múltiples de 300 + 13
By request it can be manufactured in different sizes multiples of 305,5 and 388,5 + 13



CONEXIONES | CONNECTIONS

Esquema | Diagram ON/OFF

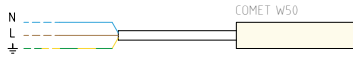

Esquema | Diagram DMX

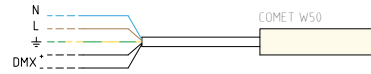

Esquema | Diagram PWM

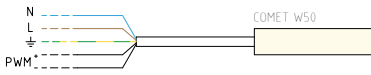

Esquema | Diagram DALI



Esquema | Diagram ON/OFF



Esquema | Diagram DALI

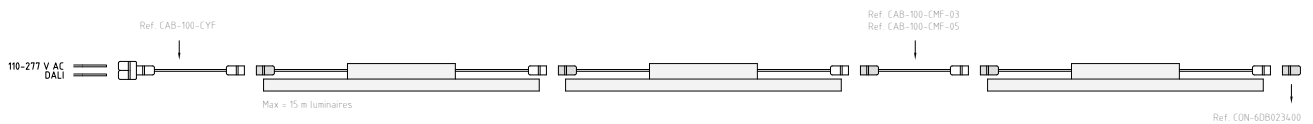

Esquema | Diagram DMX

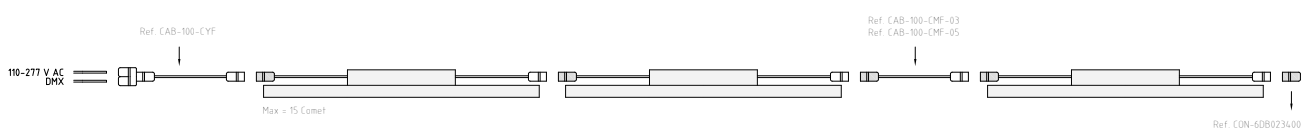

Esquema | Diagram DMX + SPLITTER

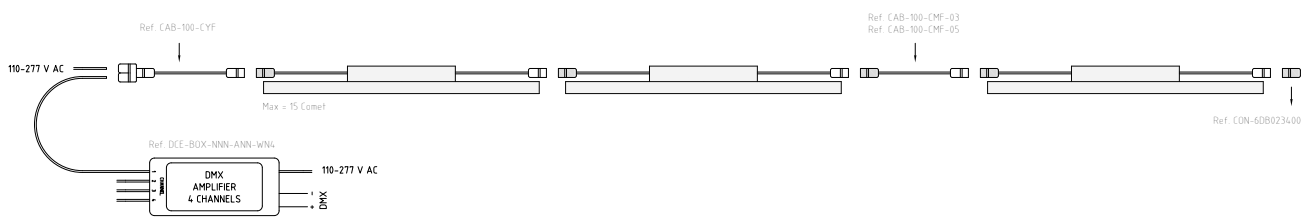



ACCESORIOS | ACCESSORIES

Conectores | Connectors



Soportes | Brackets

TIPO | TYPE A

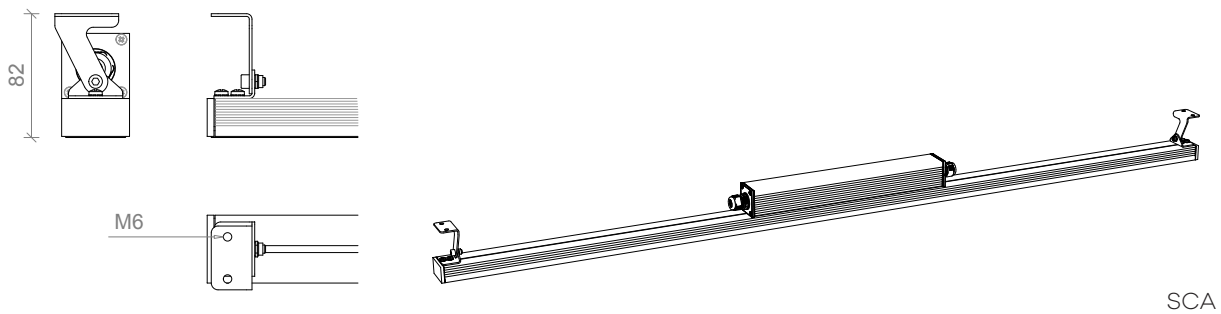

Referencia Reference	Imagen Image	Artículo Item	Descripción Description
CON-THB-387-A3A	CM3	Conector Connector	Conector macho 3 pin IP68 3 pin connector male aerial IP68
CON-THB-387-B3A	CH3	Conector Connector	Conector hembra 3 pin IP68 3 pin connector female aerial IP68
CON-THB-387-A5A	CM5	Conector Connector	Conector macho 5 pin IP68 5 pin connector male aerial IP68
CON-THB-387-B5A	CH5	Conector Connector	Conector hembra 5 pin IP68 5 pin connector female aerial IP68
CON-THB.399.D4E	CY1	Conector Connector	Conector Y IP68 Connector Y IP68
CON-6DB023400	CT1	Tapón Cab	Tapón final End cab
CAB-NNN-03		Manguera Cable	Manguera 3 cables 3-cores cable
CAB-NNN-05		Manguera Cable	Manguera 5 cables 5-cores cable
CAB-100-CYF	CH5 + CY1	Kit	Kit conector hembra 5 pin y conector Y IP68 y manguera 1000mm Kit 5 pin connector Y/ female aerial IP68 and cable 1000 mm
CAB-100-CMF-03	CM3 + CH3	Kit	Kit conector hembra y conector macho 3 pin IP68 y manguera 1000mm Kit 3 pin connector male/female aerial IP68 and cable 1000 mm
CAB-100-CMF-05	CM5 + CH5	Kit	Kit conector hembra y conector macho 5 pin IP68 y manguera 1000mm Kit 5 pin connector male/female aerial IP68 and cable 1000 mm
DCE-BOX-NNN-ANN-WN4		Driver	Amplificador DMX 4 canales DMX amplifier 4 channels
SOP-COMET-A	SCA	Soporte Bracket	Soporte tipo A Bracket type A