

COMET W60

Proyector lineal para una mezcla perfecta RGBW
Linear projector for perfect RGBW color mixing

- Proyector lineal de alto rendimiento lumínico
- Potencia: 70 W/m
- Iluminación RGB+W mezclada
- Control cada 6 LED / 300 mm
- Conexión en serie fácil y rápida
- Voltaje: 110-230 VAC | 120-277 VAC
- Cuerpo: Aluminio anodizado
- Autodireccionable o RDM

- High efficiency linear lighting fixture
- Power: 70 W/m
- Mixed RGB+W light
- Control every 6 LED / 300 mm
- Easy and quick serial connection
- Voltage: 110-230 VAC | 120-277 VAC
- Body: Anodized Aluminium
- Auto-addressable or RDM

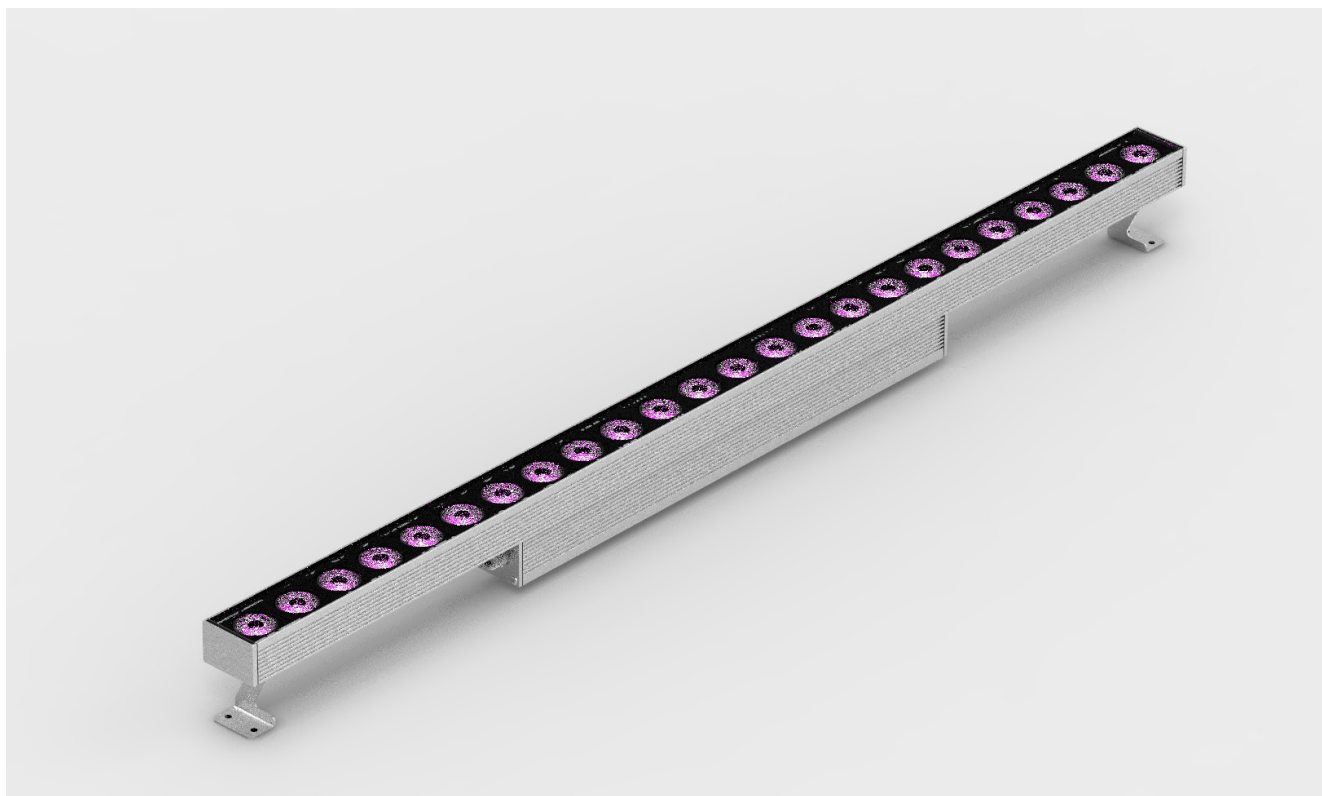
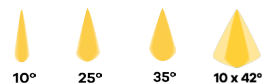



DESCRIPCIÓN | DESCRIPTION

COMET W60 es un proyector lineal de alto rendimiento lumínico diseñado para crear efectos espectaculares wall-washer en fachadas y aplicaciones arquitecturales de exterior, garantizando una luz uniforme y de alto rendimiento lumínico.

A través de una óptica mezcladora, conseguimos una emisión de luz RGB+W homogénea. El control se realiza cada 6 LED, lo que permite un "pitch" de control cada 300 mm. Auto-direccionable o direccionamiento RDM.

COMET W60 está disponible en dos longitudes (900 y 1200 mm), una amplia gama de ángulos de apertura (10°, 25°, 35° y 12x40°) y dos acabados (anodizado de plata y negra). Alimentación 110-230 VAC y control DMX.

COMET W60 is a powerful linear projector designed to create amazing wall washer effects on facades and outdoor architectural applications, with a uniform light and high light output.

Through a mixing optics, we achieve a homogeneous RGB + W light emission. Control every 6 LEDs, which allows a control "pitch" every 300 mm. Auto-addressable or RDM addressing.

COMET W60 is available in two lengths (900 and 1200 mm), a wide range of beam angles (10°, 25°, 35° and 12x40°) and two finishes (anodized silver and black). 110-230 VAC power supply and DMX control.

CARACTERÍSTICAS TÉCNICAS | TECHNICAL SPECIFICATIONS

Comet W60 RDM

Referencia Reference Modelo Model	Voltaje Voltage VAC	Potencia Power W	Frecuencia Frequency Hz	f.d.p PF	Temp. color Color temp. K	CRI	Color Color nm	Flujo Flux lm	Ángulo Beam °	Cantidad Number LED	Regulación Dimmer	Direcciones DMX DMX addresses
LCR-RHE-091-CXP-6NQ Comet W60 900	110 - 230	63	50 ~ 60	>0,95	W: 3000	>80	R: 625 G: 525 B: 455	R: 731 G: 1175 B: 355 W: 968	10 25 35 12x40	18	DMX (RDM)	12
LCR-RHE-061-CXP-6NQ Comet W60 1200		84						R: 975 G: 1566 B: 473 W: 1290		24		16

Comet W60 auto-direccionable | auto-addressable

Referencia Reference Modelo Model	Voltaje Voltage VAC	Potencia Power W	Frecuencia Frequency Hz	f.d.p PF	Temp. color Color temp. K	CRI	Color Color nm	Flujo Flux lm	Ángulo Beam °	Cantidad Number LED	Regulación Dimmer	Direcciones DMX DMX addresses
LCR-RHM-091-CXP-6NQ Comet W60 900	110 - 230	63	50 ~ 60	>0,95	W: 3000	>80	R: 625 G: 525 B: 455	R: 731 G: 1175 B: 355 W: 968	10 25 35 12x40	18	DMX	12
LCR-RHM-121-CXP-6NQ Comet W60 1200		84						R: 975 G: 1566 B: 473 W: 1290		24		16

CARACTERÍSTICAS FÍSICAS | PHYSICAL SPECIFICATIONS

Referencia Reference Modelo Model	Orientación Orientation °	Temp. trabajo Work temp. °C	Temp. stock Stock temp. °C	Dimensiones Dimensions mm	Peso Weight kg
LCR-RHx-091-CXP-6NQ Comet W50 900	180*	-20 ~ +45	-30 ~ +50	60x88x914	4
LCR-RHx-121-CXP-6NQ Comet W50 1200				60x88x1214	4,8

Referencia Reference	Protección Protection	Disipación Disipation	Radiador Radiator	Acabado Finish
LCR-	IP66	Pasiva Passive	Aluminio anodizado Anodized aluminium	Anodizado plata Silver anodized Negro Black

Otras temperaturas de color y CRI bajo pedido | Different colour temperatures and CRI under request



COMET W60

FOTOMETRÍA | PHOTOMETRY

10°

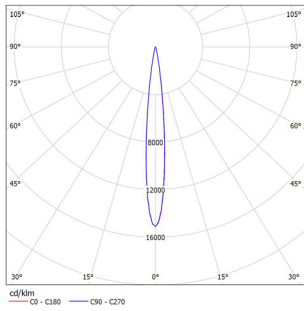

25°

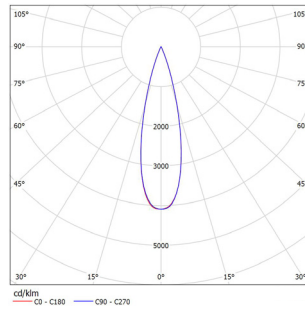

35°

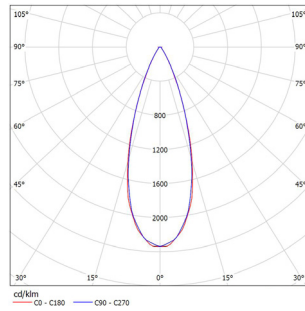

12x40°

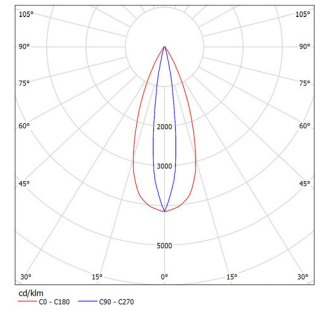

DIMENSIONES | DIMENSIONS mm

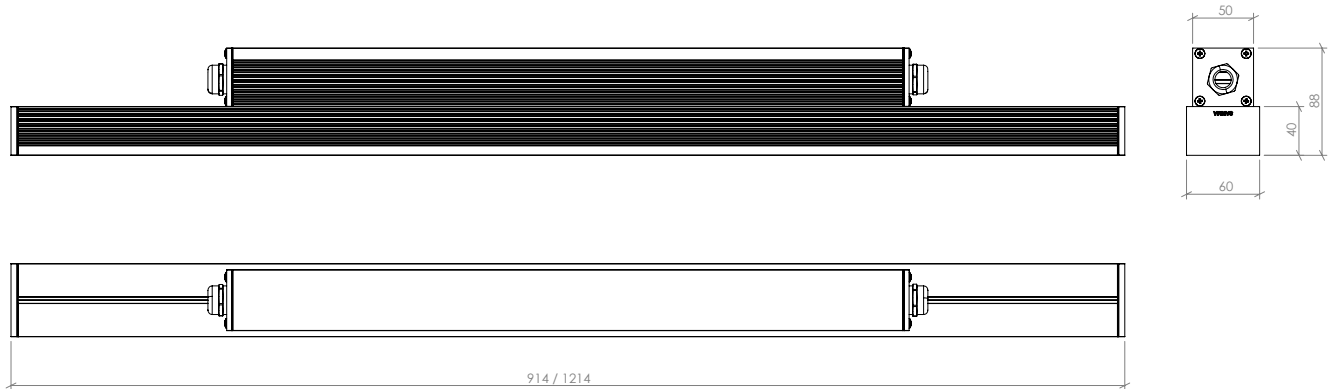

CONEXIONES | CONNECTIONS

Esquema | Diagram DMX

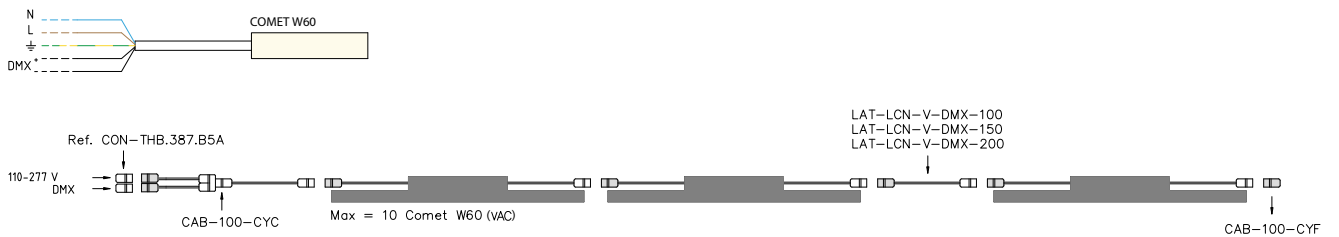

ACABADOS | FINISHES

Anodizado plata | Silver anodized



Negro | Black





ACCESORIOS | ACCESSORIES

Conectores | Connectors

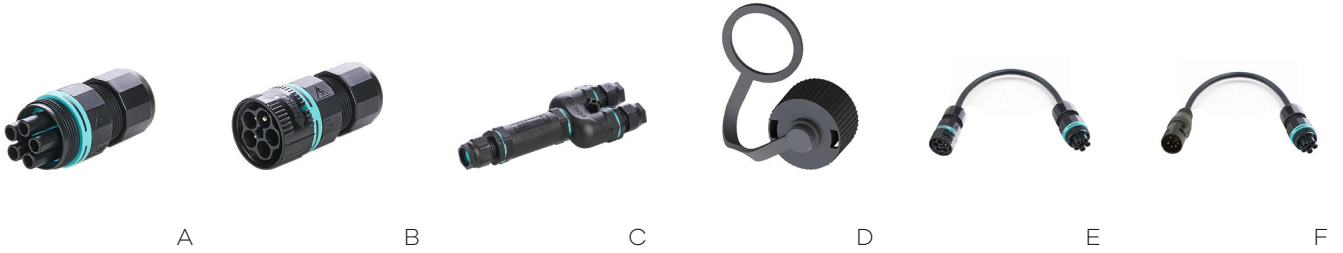

Soportes | Brackets

TIPO | TYPE A

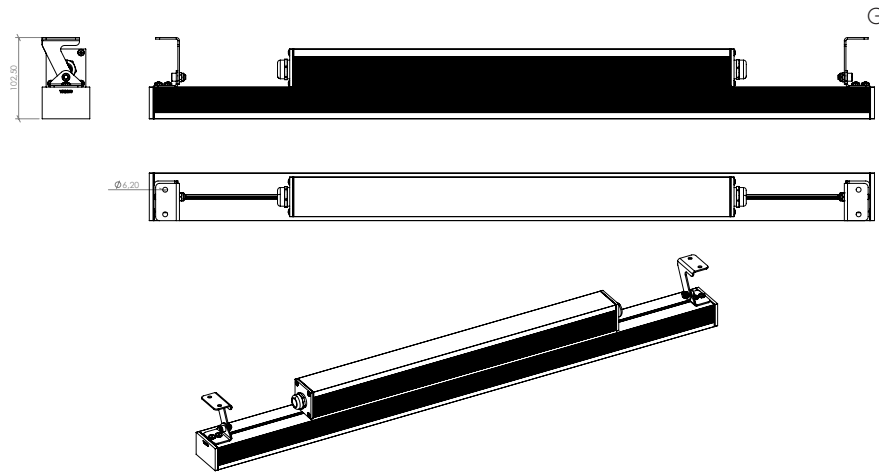

Referencia Reference	Imagen Image	Artículo Item	Descripción Description
CON-THB-387-A5A	A	Conector Connector	Conector macho 5 pin IP68 5 pin connector male aerial IP68
CON-THB-387-B5A	B	Conector Connector	Conector hembra 5 pin IP68 5 pin connector female aerial IP68
CAB-100-CYC	C	Conector Connector	Kit conector "Y" inicio + cable 500 mm. 1 x conector hebra salida + 2 x conector macho entrada (VAC+DMX) IP68 Input connectors KIT "Y" + cable 500 mm. 1 x output female connector + 2 x input male connector (VAC+DMX) IP68
CON-ENDCAP-C-DMX	F	Kit	Tapón final IP68 Endcap IP68
LAT-LCN-V-DMX-100	E	Kit	Kit conector hembra + conector macho 5 pin IP68 y manguera 1000 mm Kit 5 pin male/female aerial connector IP68 and cable 1000 mm
LAT-LCN-V-DMX-150	E	Kit	Kit conector hembra + conector macho 5 pin IP68 y manguera 1500 mm Kit 5 pin male/female aerial connector IP68 and cable 1500 mm
LAT-LCN-V-DMX-200	E	Kit	Kit conector hembra + conector macho 5 pin IP68 y manguera 2000 mm Kit 5 pin male/female aerial connector IP68 and cable 2000 mm
LAT-LCN-DMX-100	E	Kit	Kit conector hembra 5 pin + conector XLR de inicio y cable 1000 mm Kit 5 pin male/female aerial connector IP68 and cable 1000 mm
SOP-COMET-A	G	Soporte Bracket	Soporte tipo A Bracket type A



DIRECCIONAMIENTO DMX | DMX ADDRESSING

- En el modelo Comet W60 RDM se selecciona la dirección de inicio DMX de la línea de luminarias.
- Comet W60 auto-direccionable selecciona automáticamente la dirección DMX en función de la posición en la línea.
- Cada Comet W60 amplifica y regenera la señal DMX, por lo que no es necesario amplificarla cada 32 unidades.
- Comet W60 RDM selects the DMX start-address of the luminaire line.
- Comet W60 auto-addressable selects automatically the DMX address based on position on the line.
- Each Comet W60 amplifies and regenerates the DMX signal. It is not necessary amplify every 32 units.

GUÍA REFERENCIAS | REFERENCES GUIDE

Comet W60 1200

LCR-R3E-121-CAP-6GP	COMET W60, RGB+W (3000 K CRI>80), 1214 MM, 70 W/M, OPTICAL 10°, SILVER ANODIZED, 230 VAC DMX AUTO-ADDRESSABLE, IP66
LCR-R3M-121-CAP-6GP	COMET W60, RGB+W (3000 K CRI>80), 1214 MM, 70 W/M, OPTICAL 10°, SILVER ANODIZED, 230 VAC DMX/RDM, IP66
LCR-R3E-121-CCP-6GP	COMET W60, RGB+W (3000 K CRI>80), 1214 MM, 70 W/M, OPTICAL 25°, SILVER ANODIZED, 230 VAC DMX AUTO-ADDRESSABLE, IP66
LCR-R3M-121-CCP-6GP	COMET W60, RGB+W (3000 K CRI>80), 1214 MM, 70 W/M, OPTICAL 25°, SILVER ANODIZED, 230 VAC DMX/RDM, IP66
LCR-R3E-121-CDP-6GP	COMET W60, RGB+W (3000 K CRI>80), 1214 MM, 70 W/M, OPTICAL 35°, SILVER ANODIZED, 230 VAC DMX AUTO-ADDRESSABLE, IP66
LCR-R3M-121-CDP-6GP	COMET W60, RGB+W (3000 K CRI>80), 1214 MM, 70 W/M, OPTICAL 35°, SILVER ANODIZED, 230 VAC DMX/RDM, IP66
LCR-R3E-121-CSP-6GP	COMET W60, RGB+W (3000 K CRI>80), 1214 MM, 70 W/M, OPTICAL 12x40°, SILVER ANODIZED, 230 VAC DMX AUTO-ADDRESSABLE, IP66
LCR-R3M-121-CSP-6GP	COMET W60, RGB+W (3000 K CRI>80), 1214 MM, 70 W/M, OPTICAL 12x40°, SILVER ANODIZED, 230 VAC DMX/RDM, IP66
LCR-R3E-121-CAB-6GP	COMET W60, RGB+W (3000 K CRI>80), 1214 MM, 70 W/M, OPTICAL 10°, BLACK ANODIZED, 230 VAC DMX AUTO-ADDRESSABLE, IP66
LCR-R3M-121-CAB-6GP	COMET W60, RGB+W (3000 K CRI>80), 1214 MM, 70 W/M, OPTICAL 10°, BLACK ANODIZED, 230 VAC DMX/RDM, IP66
LCR-R3E-121-CCB-6GP	COMET W60, RGB+W (3000 K CRI>80), 1214 MM, 70 W/M, OPTICAL 25°, BLACK ANODIZED, 230 VAC DMX AUTO-ADDRESSABLE, IP66
LCR-R3M-121-CCB-6GP	COMET W60, RGB+W (3000 K CRI>80), 1214 MM, 70 W/M, OPTICAL 25°, BLACK ANODIZED, 230 VAC DMX/RDM, IP66
LCR-R3E-121-CDB-6GP	COMET W60, RGB+W (3000 K CRI>80), 1214 MM, 70 W/M, OPTICAL 35°, BLACK ANODIZED, 230 VAC DMX AUTO-ADDRESSABLE, IP66
LCR-R3M-121-CDB-6GP	COMET W60, RGB+W (3000 K CRI>80), 1214 MM, 70 W/M, OPTICAL 35°, BLACK ANODIZED, 230 VAC DMX/RDM, IP66
LCR-R3E-121-CSB-6GP	COMET W60, RGB+W (3000 K CRI>80), 1214 MM, 70 W/M, OPTICAL 12x40°, BLACK ANODIZED, 230 VAC DMX AUTO-ADDRESSABLE, IP66
LCR-R3M-121-CSB-6GP	COMET W60, RGB+W (3000 K CRI>80), 1214 MM, 70 W/M, OPTICAL 12x40°, BLACK ANODIZED, 230 VAC DMX/RDM, IP66

Comet W60 900

LCR-R3E-091-CAP-6GP	COMET W60, RGB+W (3000 K CRI>80), 914 MM, 70 W/M, OPTICAL 10°, SILVER ANODIZED, 230 VAC DMX AUTO-ADDRESSABLE, IP66
LCR-R3M-091-CAP-6GP	COMET W60, RGB+W (3000 K CRI>80), 914 MM, 70 W/M, OPTICAL 10°, SILVER ANODIZED, 230 VAC DMX/RDM, IP66
LCR-R3E-091-CCP-6GP	COMET W60, RGB+W (3000 K CRI>80), 914 MM, 70 W/M, OPTICAL 25°, SILVER ANODIZED, 230 VAC DMX AUTO-ADDRESSABLE, IP66
LCR-R3M-091-CCP-6GP	COMET W60, RGB+W (3000 K CRI>80), 914 MM, 70 W/M, OPTICAL 25°, SILVER ANODIZED, 230 VAC DMX/RDM, IP66
LCR-R3E-091-CDP-6GP	COMET W60, RGB+W (3000 K CRI>80), 914 MM, 70 W/M, OPTICAL 35°, SILVER ANODIZED, 230 VAC DMX AUTO-ADDRESSABLE, IP66
LCR-R3M-091-CDP-6GP	COMET W60, RGB+W (3000 K CRI>80), 914 MM, 70 W/M, OPTICAL 35°, SILVER ANODIZED, 230 VAC DMX/RDM, IP66
LCR-R3E-091-CSP-6GP	COMET W60, RGB+W (3000 K CRI>80), 914 MM, 70 W/M, OPTICAL 12x40°, SILVER ANODIZED, 230 VAC DMX AUTO-ADDRESSABLE, IP66
LCR-R3M-091-CSP-6GP	COMET W60, RGB+W (3000 K CRI>80), 914 MM, 70 W/M, OPTICAL 12x40°, SILVER ANODIZED, 230 VAC DMX/RDM, IP66
LCR-R3E-091-CAB-6GP	COMET W60, RGB+W (3000 K CRI>80), 914 MM, 70 W/M, OPTICAL 10°, BLACK ANODIZED, 230 VAC DMX AUTO-ADDRESSABLE, IP66
LCR-R3M-091-CAB-6GP	COMET W60, RGB+W (3000 K CRI>80), 914 MM, 70 W/M, OPTICAL 10°, BLACK ANODIZED, 230 VAC DMX/RDM, IP66
LCR-R3E-091-CCB-6GP	COMET W60, RGB+W (3000 K CRI>80), 914 MM, 70 W/M, OPTICAL 25°, BLACK ANODIZED, 230 VAC DMX AUTO-ADDRESSABLE, IP66
LCR-R3M-091-CCB-6GP	COMET W60, RGB+W (3000 K CRI>80), 914 MM, 70 W/M, OPTICAL 25°, BLACK ANODIZED, 230 VAC DMX/RDM, IP66
LCR-R3E-091-CDB-6GP	COMET W60, RGB+W (3000 K CRI>80), 914 MM, 70 W/M, OPTICAL 35°, BLACK ANODIZED, 230 VAC DMX AUTO-ADDRESSABLE, IP66
LCR-R3M-091-CDB-6GP	COMET W60, RGB+W (3000 K CRI>80), 914 MM, 70 W/M, OPTICAL 35°, BLACK ANODIZED, 230 VAC DMX/RDM, IP66
LCR-R3E-091-CSB-6GP	COMET W60, RGB+W (3000 K CRI>80), 914 MM, 70 W/M, OPTICAL 12x40°, BLACK ANODIZED, 230 VAC DMX AUTO-ADDRESSABLE, IP66
LCR-R3M-091-CSB-6GP	COMET W60, RGB+W (3000 K CRI>80), 914 MM, 70 W/M, OPTICAL 12x40°, BLACK ANODIZED, 230 VAC DMX/RDM, IP66